



Southwest Energy Efficiency Project

Saving Money and Reducing Pollution through Energy Conservation

New Evaporative Cooling Systems: An Emerging Solution for Homes in Hot Dry Climates with Modest Cooling Loads

Prepared for

U.S. Department of Energy

Building America Program

Through the

**Midwest Research Institute
National Renewable Energy Laboratory Division**

N.B. All readers are invited to comment this document. Please direct comments to its author, Larry Kinney, at the address and phone below; email lkinney@swenergy.org.

This report on new emerging evaporative cooling options is one a series of technical briefs being prepared by the Southwest Energy Efficiency Project (SWEET) in support of the U.S. Department of Energy's Building America Program. Its intended audience is builders and design professionals interested in employing technologies that will reduce energy costs in both new and existing housing stock. Feedback from all readers on the form and content of this report are welcome. A companion report, "Evaporative Cooling Policy Options: Promising Peak Shaving in a Growing Southwest," is aimed at energy program policy makers, planners, and analysts. It includes information on energy and economic analyses associated with various levels of the penetration of evaporative cooling technology and associated policy options. Both reports are available for downloading at www.swenergy.org.

Introduction

There's a world of difference between old-style swamp coolers and modern evaporative cooling systems. The latter can provide years of trouble-free service and cool, clean, comfortable, fresh air at a lower energy cost than conventional air conditioners—and initial costs are competitive as well. In addition, the latest evaporative cooler designs are a lot easier on the grid than compressor-based cooling systems. Instead of peak demands of three to five kilowatts (kW) or more, typical demands for mid-size evaporative coolers are on the order of one kW. In addition to improved performance, modern evaporative coolers include options for thermostatic control and automated flushing of reservoir water to reduce buildup of impurities. Accordingly, widespread use of evaporative coolers can help delay adding expensive new power plants to the electric grid and the controversial transmission lines that often accompany them. That's the reason a number of utility companies in areas with hot, dry summers and substantial population growth have programs to promote efficient evaporative coolers.

How Evaporative Cooling Works

When air blows through a wet medium—a tee shirt, aspen fibers (excelsior), or treated cellulose, fiberglass, or plastic—some of the water is transferred to the air and its dry bulb temperature is lowered. The cooling effect depends on the temperature difference between dry and wet bulb temperatures, the pathway and velocity of the air, and the quality and condition of the medium.

Dry bulb and wet bulb temperature: The temperature of air measured with a thermometer whose sensing element is dry is known as “dry bulb temperature.” If a thermometer's sensing element is surrounded by a wet wick over which air is blown, the sensor is evaporatively cooled to its “wet bulb” temperature. When the relative humidity is at 100%, there is no difference between dry and wet bulb temperatures, but as the relative humidity of the air drops, so does the wet bulb temperature with respect to dry bulb temperature. In climates such as those in the Southwest, where humidity is routinely quite low, the differences are substantial. For example, at 10 percent relative humidity and a dry bulb temperature of 90°F, the wet bulb temperature is 58°F, a 32 degree difference. This is often called the “depression” of wet bulb below dry bulb. Climates with such large depressions favor evaporative cooling techniques, as shown in Figure 1.

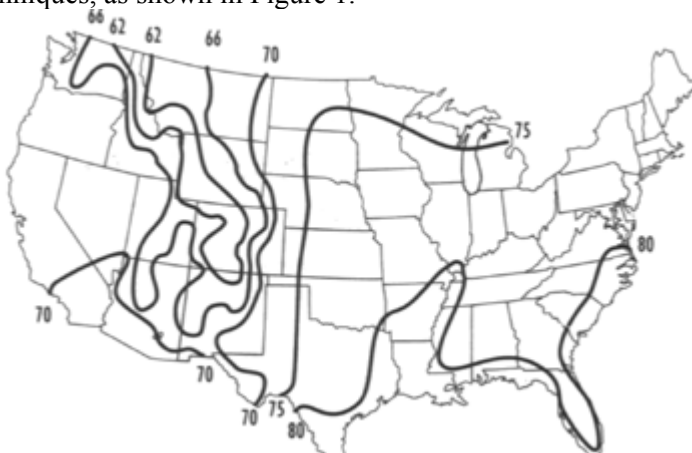

Source: Roy Otterbein, Otterbein Engineering; Home Energy, May/June 1996

Figure 1. Wet bulb temperature map

The map shows lines of equal wet bulb temperatures which are not exceeded for more than 1% of the time during the cooling season. Weather regions with 1% wet bulb temperatures of 70°F or below can be comfortably cooled with direct evaporative coolers, and those with 1% wet bulb temperatures of up to 75°F can be made comfortable for many people. Some areas of the Southwest (primarily in the low desert of Arizona), experience a late summer “monsoon season” during which humid conditions reduce the effectiveness of evaporative cooling systems for several weeks at a time. Many households use conventional cooling systems as a backup to their evaporative cooling systems during these periods.

Types of Evaporative Coolers

“Direct” evaporative coolers use a fan to pull outside air through media (pads) that are kept thoroughly wet by water that is sprayed or dripped on them (Figures 2 and 3). This both filters the air and cools it. The water is typically delivered via tubes from a small pump which draws from a reservoir below. The reservoir is replenished with tap water whose level is controlled by a float valve. The resulting fresh, cool, humidified air is blown into buildings where the pattern of flow (and cool air delivered) is determined by the location and extent of openings in the conditioned envelope such as windows or special dedicated ducts.

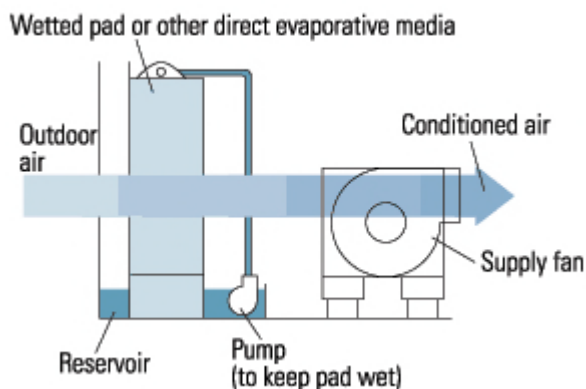

Source: Platts

Figure 2. Direct evaporative cooler. Air is pulled across a thoroughly wetted medium as evenly as possible. Lower speeds give more exposure time to the wetted media, thereby achieving more cooling.

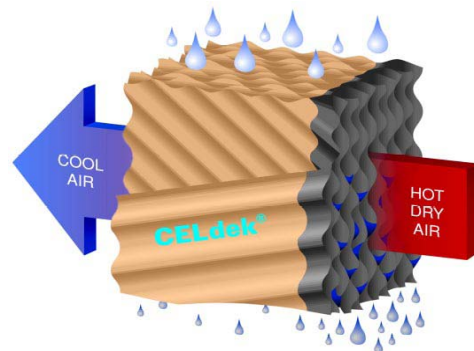

Source: Munters

Figure 3. Modern evaporative cooling media Media for evaporative coolers has to be efficient, which means that it must allow for as much cooling as temperature conditions allow while minimizing pressure drop, thereby saving fan power. Well-designed media filters the air stream, but is also self-cleaning, in that water dripping across it to the sump below performs a cleaning function. Finally, it should be durable and easy to replace at the end of its functional lifetime. Master Cool™ from Munters uses alternating corrugated layers to achieve these ends.

Modern evaporative coolers couple high-performance media with low-velocity air flow. They maximize moisture transfer as the air traverses the media to enhance “direct saturation effectiveness,” which is analogous to cooling efficiency. Direct evaporative cooler performance is measured relative to the wet bulb “depression.” Well-designed systems with thick (10 to 12 inches or more) media operating properly can achieve 93% effectiveness, whereas older style systems that typically use 2 inches of excelsior may achieve effectiveness of 50% to at most 80%. Although they are less expensive, since these less efficient units also tend to waste water (see discussion below), we do not recommend their use.

“Indirect” evaporative coolers take advantage of evaporative cooling effects, but cool without raising indoor humidity. Figure 4 shows a common configuration of indirect cooling that makes use of an air-to-air heat exchanger. The main fan supplies outside air through the dry passages of a heat exchanger into the dwelling, while a secondary fan delivers exhaust air from the dwelling, fresh air, or some combination through wetted passages in thermal contact with the dry passages of the heat exchanger. A variation, called “indirect/direct,” adds a second stage of evaporative cooling before the conditioned air enters the dwelling to further lower the temperature of the incoming air. Efficient indirect/direct units can deliver air that is cooler than the outside wet bulb temperature.

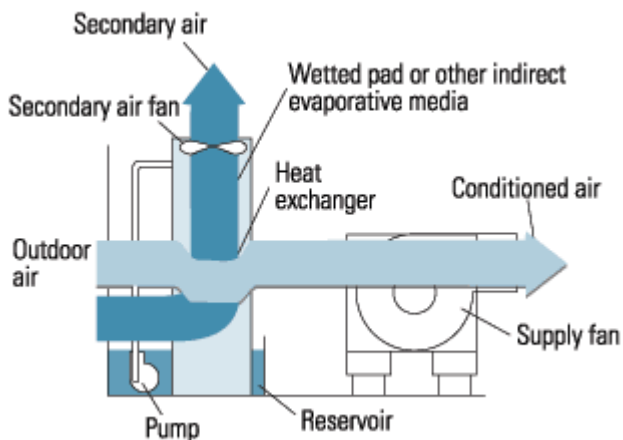

Source: Platts

Figure 4. Indirect evaporative cooling Indirect evaporative cooling doesn’t add humidity to the conditioned space.

Table 1 shows delivery temperature at 85% saturation effectiveness (corresponding to a good quality direct cooler) and delivery temperature at 105% (corresponding to a good quality indirect/direct two stage evaporative cooler) for seven Southwestern cities. For comparison, a conventional cooling system typically delivers air at 55F before it is distributed through ductwork throughout the house. Since the cooling energy delivered depends on both the difference in temperature between the air delivered and the indoor air temperature and the quantity of air delivered, evaporative coolers routinely operate at higher air flow rates than do conventional central air conditioning (CAC) systems.

Table 1. Delivery temperatures for selected cities. Note that these delivery temperatures are under severe conditions. During 99 percent of the typical cooling season, ambient temperatures (and delivery temperatures) are lower than those shown in the table.

City	Dry bulb ambient temp (°F)	Wet bulb ambient temp (°F)	Depression (°F)	Temp delivered @ 85% effectiveness (°F)	Temp delivered @ 105% effectiveness (°F)
Albuquerque	93	60	33	65	58
Cheyenne	85	57	28	61	56
Denver	90	59	31	64	57
Las Vegas	106	66	40	72	64
Phoenix	108	70	38	76	68
Salt Lake City	94	62	32	67	60
Tucson	102	65	37	71	63

Source: 2001 ASHRAE Handbook of Fundamentals, Chapter 27

Distribution

Evaporative coolers use a “flow-through” air distribution process rather than the recirculated air distribution process used with conventional cooling systems. The least costly air distribution strategy for evaporative coolers is to rely on windows to exhaust air brought into the space by the cooling unit. More air flows through windows that are opened the widest or are closest to the supply. Thus, it is possible to cool certain areas of the home more than others by manipulating the flow of air toward partially-open windows which double as exhaust ports.

In recent years, however, an increasing number of evaporative cooler installations make use of pressure relief dampers, often called “up-ducts,” instead of windows. These are effectively back-draft dampers installed in the attic floor with associated grills in the top floor ceiling. These dampers open in response to positive pressure caused by air flow from an evaporative cooler (Figure 5). The exhaust air flows out of the conditioned envelope, thorough the attic, and outside via existing attic ventilation pathways such as gable, roof, and ridge vents. If up-ducts are appropriately located, the result is good distribution of fresh, cooled air without the need to open windows. Since cool air descends, comfort can be achieved on the first floor of two story homes even when all the exhaust openings are on the second floor. This distribution approach is consistent with fully-automated cooling even when the home is unoccupied, without the security risks associated with open windows. A secondary consequence is that attic air temperature is also lowered, thereby reducing the cooling load and improving the net efficiency of the cooling process.



Figure 5. Up duct. The grill of this up-duct is secured to the ceiling while the upper portion extends into the attic. Of course, insulation should be packed around the duct, but not on top. This model includes an insert to prevent air exfiltration during the heating season.

When an evaporative cooler relies on up-ducts, it's important to have adequate outlets into the attic as well as adequate outlets from the attic to the outside. The former ensure uniform cooling without pressurizing the home, and the latter ensure that moisture-laden air is quickly moved out of the attic. A good rule of thumb for both up duct and attic ventilation areas is 2 square feet per 1,000 cubic feet per minute (cfm) of air flow *actually delivered* from the evaporative cooler.

(The product literature from evaporative cooler manufacturers cites nominal flow rates—termed “energy standard cfm ratings”—that are routinely 30% to 50% greater than actual flow rates.)

Attic Installation

In recent years, high-quality evaporative coolers are increasingly being installed in attics, where outside air is supplied through a short duct to the cooler, which in turn cools air and delivers it through one or more ducts to the space below, typically hallways. Coolers used for such applications draw in make-up air from only one side and use thicker, more efficient media for this application. When attics are sufficiently large to accommodate the cooling equipment, this option can be desirable. It keeps cooling equipment away from inclement weather, which is impossible for roof or side-yard-mounted coolers. (Some people regard roof-mounted cooling equipment as being unsightly, and some neighborhoods have covenants against it.) However,

because the attic space can get very hot during peak cooling months, some cooling capacity may be lost due to heat gains from the attic, especially if distribution is achieved via windows rather than up-ducts. Unintentional water leaks can also damage ceilings if the unit is installed in a cold climate and pipes freeze due to insufficient maintenance of the evaporative cooling unit at the end of the cooling season. An alternative approach is to insulate the attic at the roof plan, thereby converting it into a conditioned space that both reduces chances of freezing and lowers summer heat gains.

Direct Drive Service, a Colorado-based HVAC company, specializes in installing evaporative coolers in the attics of high-end homes, both new and retrofit (Figures 6 and 7). The evaporative cooling equipment is installed with vibration-suppressing techniques and routinely uses up-ducts.



Source: Direct Drive Service



Source: Direct Drive Service

Figure 6. Fresh air intakes. These attics have evaporative coolers installed less than a foot from this intake air vent. Vents are closed during the heating season. An option under consideration is the addition of outside insulating shutters.

The systems also use digital controls that maintain both comfort and water quality, and aid end-of-season maintenance. The control varies fan speed according to the degree of cooling needed, running the fan motor on low speed when actual temperature is within 3°F of the thermostat set point temperature (Figure 8). This maximizes cooling efficiency, diminishes cooling energy use, and creates comfort with very little noise. Of significance, when evaporative coolers are controlled by thermostats, it is prudent to install pressure relief devices to make certain the home is not inadvertently pressurized when no one is home. Some utility rebate programs require a proof of purchase of up-ducts or other pressure relief devices as a condition for receiving a rebate.



Source: Direct Drive Service

Figure 7. Typical attic installation. The cooler is installed close to the fresh air intake and moves air into 24 inch diameter supply ducts that are well insulated (improving energy performance and reducing noise) and relatively short, as they typically feed conditioned air into an upstairs hallway. Intake air ducts range from 28 x 42 inches to 24 x 36 inches, where the smaller size will accommodate a 3,000 cfm evaporative cooler. The cooler is suspended from trusses and uses vibration isolators at top and bottom. In the interests of safety, an electric cut-off is installed close to the unit so it can be maintained without risk of shock.

Water issues

Evaporating a pound of water yields about 1061 Btu of cooling. Accordingly, if the process were 100% effective, a gallon of water could yield 8,700 Btus of evaporative cooling. Water is used to thoroughly wet a medium in the air stream, which tends to dry the medium and cool the air. Ideally, if the flow of water and the flow of air are well matched in a carefully-designed evaporative cooler, the air is cooled efficiently and most of the water is evaporated. However, some extra water is important to flush the residue of air pollutants and scale in the water. In inefficient units, water that is not evaporated by the cooler is continuously diluted by make-up water in the reservoir (sump), the residue going down an overflow drain. This “bleed” system continuously dilutes the water and reduces the concentration of scale and impurities, but this method of cleaning wastes water.

Finally, an auxiliary pan and associated drain is placed under the unit to deal with overflow in the case of the failure of the float valve switch.

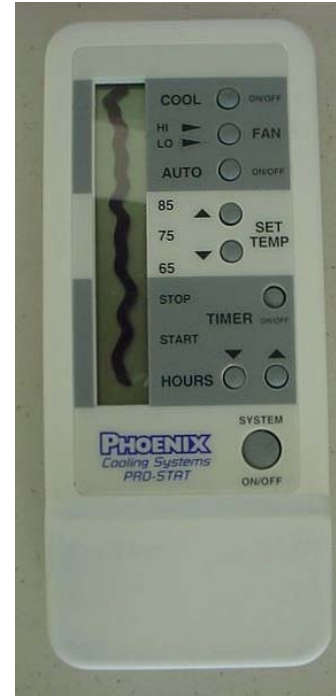

Source: Direct Drive Service

Figure 8. Digital control. This control enables ventilation as well as cooling and can work as either a timer or conventional thermostat. It automatically actuates a cleaning and draining operation of the system’s sump, but also allows manual operation of the drain system to facilitate end-of-season maintenance.

Higher-quality units use a more effective and less wasteful batch process to deal with impurities. The sump is typically sloped so that heavier pollutants and scale tend to collect at the bottom. Instead of continuous dilution, after an elapsed running time of the cooler of several hours, the reservoir is drained and flushed automatically. The residue of several gallons from this “sump dump” may be piped to a nearby garden. With this system of periodic purging, almost all of the water is used to provide cooling. The discharged portion is well matched to the needs of a garden—more water is delivered on hot days when the evaporative cooler works the most and plants are especially thirsty.

While an evaporative cooler does consume a significant amount of water, it also saves water consumed at the power plant (assuming a less energy-efficient compressor-based air conditioner would be used for cooling if the evaporative cooler were not used). Generating a kWh of electricity with a new coal plant in the Southwest uses about 0.67 gallons of water, while a new natural-gas-fired plant consumes about 0.33 gallons of water per kWh generated.¹ Since conventional direct expansion (DX) air conditioning systems use substantially more energy than do evaporative coolers, water use at the power plant (source) is proportionally greater. SWEEP used Energy 10 software to estimate the energy consequences of DX versus evaporative cooling using modern equipment in six Southwestern cities. Results are shown in Table 2. The homes modeled are quite efficient 1800 square foot structures whose overall energy use is 48 percent lower than homes that just meet the requirements of the year 2000 International Energy Conservation Code for the weather regions associated with each city. We assumed the DX systems have an energy efficiency rating (EER) of 11.1 (roughly corresponding to a seasonal energy efficiency rating, SEER, of 12.9) and a thermostat set point of 76 degrees F. We also assumed a run time of the evaporative coolers to exceed that of the replaced conventional air conditioning systems by 43% at an average power consumption of 800 watts.

Table 2. Water and energy use in the Southwest. Estimates of energy and water use in an 1800 square foot new home in six Southwestern cities that exceed ENERGY STAR® standards by about 15% , comparing DX and evaporative cooling systems. Averages weighted by projected population growth.

Table 2. Water and Energy Use in the Southwest

City	Cooling Energy DX (kWh/yr)	Cooling Energy Evap (kWh/yr)	Energy Saved (kWh/yr)	DX Source Water Use (gal)	Evap Source Water Use (gal)	Water Saved at Source (gal)	Evap Site Water Use (gal)	Net Evap Water Use (gal)	Annual increase HH water use due to evap cool (%)
Albuquerque	2,487	334	2,153	1244	167	1,077	3,470	2,394	2.6%
Cheyenne	1,773	287	1,485	886	144	743	2,435	1,692	1.4%
Denver	1,935	279	1,656	968	140	828	2,685	1,857	1.7%
Las Vegas	4,722	497	4,225	2361	249	2,112	6,696	4,583	2.6%
Phoenix	6,043	574	5,469	3022	287	2,735	8,619	5,884	5.1%
Salt Lake City	2,839	357	2,483	1420	178	1,241	3,981	2,739	2.1%
SW Average	4,063	438	3,625	2,032	219	1,813	5,754	3,941	3.3%

Source: Increasing Energy Efficiency in New Buildings in the Southwest, SWEEP, 2003; SWEEP estimates

¹ See *The New Mother Lode: The Potential for More Efficient Electricity Use in the Southwest*, SWEEP, 2002. Available for downloading at www.swenergy.org/nml/index.html.

According to this analysis, modern residential evaporative coolers in the Southwest use an average of 5,754 gallons of water per year at the site, ranging from 2,435 gallons in Cheyenne to 8,619 gallons in Phoenix. For single-family households, this amount of water use represents an average of only 3.3% of annual water use. However, from the overall environmental point of view that takes into account water used at the power station, net water use averages 3,941 gallons of water per year, ranging from 1,692 gallons in Cheyenne to 5,884 gallons in Phoenix. On average in the Southwest, net water use is 68% of the water used at the site. Nonetheless, because evaporative coolers increase local water consumption and water savings at the power plant are not provided to the local water district, the increase in local water use which results from the use of evaporative cooling can have an impact on water planning.

The above analysis ignores the very significant use of water associated with the generation of electricity with hydroelectric plants. Damming a river to harness its potential to generate electricity raises the surface area of the newly-formed lake by several orders of magnitude. Nationally, the result is that 18 gallons of water are evaporated for every kWh of hydroelectric energy produced.² In the Southwest, where the air is frequently both hot and dry, the average (weighted by consumption) is 69 gallons per kWh of hydroelectric energy generated. Accordingly, were we to include hydro in our estimates of total water use at the generator, the average in the Southwest would be 4.88 gal/kWh instead of the 0.5 gal/kWh figure used. The rationale for not including hydro is that it is already fixed in place, typically used as base load generation, and not likely to be expanded to meet new demand. Accordingly, the energy and demand savings achieved by substituting energy-efficient evaporative cooling equipment for CAC equipment will save having to add additional thermo-electric generation capacity, typically gas and coal-fired power plants.

Savings in electricity use—and cost—achieved by using evaporative instead of DX-based cooling are also quite substantial. Operating cost figures is shown in Table 3.

Table 3. Cooling cost comparisons. Annual cost to the end user of cooling 1800 square foot new homes in six Southwestern cities that exceed ENERGY STAR standards by about 15%, comparing DX and evaporative cooling. When local water rates are higher with increased consumption, the computations shown assume the higher marginal cost per gallon of water used. Water and electricity rates applicable to single family residences in each city in 2003 were used to estimate costs.

City	Cooling Energy DX Cost (\$/yr)	Cooling Energy Evap Cost (\$/yr)	Cooling Energy Saved with Evap (\$/yr)	Evap Water Cost (\$/yr)	Total Evap Cooling Cost (\$/yr)	Net Savings Evap vs DX (\$/yr)
Albuquerque	\$214	\$29	\$185	\$5	\$33	\$181
Cheyenne	\$151	\$24	\$126	\$6	\$30	\$121
Denver	\$141	\$20	\$121	\$5	\$25	\$116
Las Vegas	\$444	\$47	\$397	\$13	\$60	\$384
Phoenix	\$502	\$48	\$454	\$20	\$68	\$434
Salt Lake City	\$185	\$23	\$161	\$5	\$28	\$157
SW Average	\$335	\$36	\$299	\$12	\$48	\$287

² P. Torcellini, N. Long, and R. Judkoff. NREL/CP-550-35190. November 2003. "Consumptive Water Use for U.S. Power Production." Available electronically at <http://www.nrel.gov/docs/fy04osti/35190.pdf>

Annual water costs for evaporative cooling average \$12 per year in the efficient homes analyzed in the Southwest, ranging from \$5 in Albuquerque, Denver, and Salt Lake City to \$20 in Phoenix. On average, water costs with evaporative cooling diminish energy saving dollars by only about 4%. Even accounting for water costs, overall cooling season savings average \$287 per year in energy efficient homes in the Southwest, ranging from \$116 in Denver to \$434 in Phoenix. Further, lower electricity demand may help delay building new power plants with their associated water use, air pollution, and fossil fuel consumption, provided that they are designed and installed in a way that they effectively reduce peak cooling loads even during the monsoon seasons in areas where they occur.

First Costs

First costs of cooling equipment tend to be a function of its efficiency, whether the systems are conventional or evaporative coolers. This trend in the case of conventional systems is illustrated in Table 4 for compressor-based central air conditioning. The table also shows labor costs for installation.

Table 4. Equipment and installed costs in 2003 \$ for split system and package system central air condition systems as a function of equipment efficiency.

Performance Index		Split system central A/C		Package system central A/C	
SEER	EER	Equipment cost (\$)	Installed cost (\$)	Equipment cost (\$)	Installed cost (\$)
12	10	1,283	2,754	1,580	3,152
13	11	1,439	2,910	1,915	3,487
13	11.6	1,485	2,956	2,038	3,610
14	12	1,752	3,223	2,406	3,978
15	13	1,957	3,428	2,414	3,986
16	14	1,967	3,438	2,714	4,286

Source: Heschong Mahone Group; U.S. DOE Energy Efficiency and Renewable Energy, http://www.eere.energy.gov/buildings/appliance_standards/residential/docs/cac_lcc-rev2.xls

Split systems have over three times the market share as do packaged systems. Average costs weighted for market share are \$1,771 for A/C equipment and \$3,265 for installed costs.

The equipment for single-stage evaporative cooling systems with a saturation effectiveness of greater than 80% under all operating conditions, variable (or at least two) speed motors, and a sump-dump feature for effective cleaning with minimal water use, range in cost from \$600 to \$1,120, depending on saturation effectiveness and blower horsepower (see Appendix A). Blower horsepower is the principal determining factor in air flow rates. Equipment for two-stage (indirect/direct) evaporative coolers whose saturation effectiveness is in the 105% to 110% range is \$1,700 to slightly less than \$3,000. Installation costs are lower than for central air

conditioning systems in large measure because of substantially simplified ducting. Installations on a concrete pad next to a home run from \$600 to \$1000 while attic installations run from \$800 to \$1,400, depending on the number of up-ducts that must be installed and other factors.

Considering these cost ranges, the total installed cost for an efficient single-stage efficient evaporative cooling system is typically between \$1,600 to \$2,200. The total installed cost for an efficient two-stage evaporative cooler is on the order of \$2,500 to \$3,500. In general, installed costs of efficient evaporative equipment are lower than are installed costs for comparable compressor-based central cooling systems. Lifetime costs are much less.

Choosing efficiency

As with conventional air conditioning systems, evaporative coolers that deliver more cooling cost more to purchase, more to operate, and make more noise (because they must move more air.) To optimize economic and energy performance, as well as to maximize comfort, it's best to ensure that the home's envelope is well insulated, that windows have low solar heating gain coefficients (SHGC), and that effective exterior shading devices (overhangs, fins, shutters, louvers, strategically-located vegetation) are employed to block direct beam sunshine during the cooling season. These strategies will lower the cooling load and enable smaller, less-expensive cooling equipment.

In general, low-end, direct systems which use only several inches of media (that must be replaced frequently) are inefficient and waste water. Although their low cost makes them attractive for some uses, they are generally a bad choice for the long term. Better by far are single-inlet systems with thick media resulting in saturation effectiveness of at least 80% under all operating conditions, variable speed motors, a sump-dump feature for effective cleaning with minimal water use, and thermostatic controls. Appendix A includes a list of manufacturers of evaporative coolers that meet these criteria.

Indirect/direct evaporative coolers can achieve comfort in a wider range of climate zones than can direct machines since they are capable of delivering air that is several degrees below wet bulb temperature, and which is drier than the air delivered by direct coolers. As a consequence, they are well matched to climates in such fast-growing areas as Las Vegas, Tucson, and Phoenix.

Only two manufacturers are currently producing indirect/direct evaporative coolers for the residential market. AdobeAir's Model 6500 Master Cool unit has been in the market for almost a decade. As shown in Figure 9, one or two indirect cooling stages may be added to the outside air side of a direct evaporative cooling unit. It uses 12 inch thick media and a 1 horsepower blower to deliver conditioned air that is several degrees below outside air wet bulb temperature under most circumstances. Each indirect module has its own small fan to move air through the wet passages. On a hot day in which dry bulb temperature is 104°F and wet bulb is 69°F, according to the company's product literature, AdobeAir's MasterCool direct system with no indirect cooling module delivers 75°F air to the conditioned space, and has 33,600 Btu/hour cooling capacity. With the addition of one indirect cooling module, the system produces 68°F air delivering 56,400 Btu/hour, and with two indirect cooling modules, 66°F air delivering 81,600

Btu/hr of cooling energy. Compared with a DX unit with a SEER of 12, operating costs (energy and water) are at least 70% lower for AdobeAir's indirect/direct system in most hot climate zones.

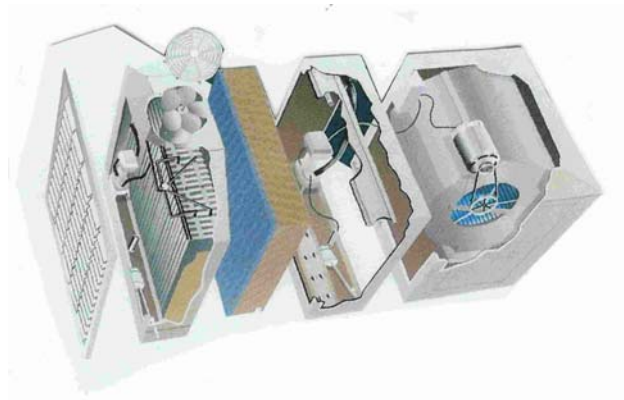

Source: AdobeAir

Figure 9. AdobeAir's MasterCool indirect/direct evaporative cooler. Adobe's design allows attaching one or two indirect cooling modules to the direct module, thereby raising the overall effectiveness of the system. Note that the indirect modules have their own separate fan for the "wet" side of the indirect cooler's heat exchanger.

Speakman CRS (for "Clean, Renewable, Sustainable") is a branch of the Speakman Company, a Delaware firm that has been producing shower heads and other water-related products for more than 130 years. The company has recently decided to manufacture and distribute a newly-modified indirect/direct evaporative cooler called the OASys, which was developed by the Davis Energy Group in Davis, California. Although Speakman CRS "will take purchase orders now" (the spring of 2004), delivery of the systems is expected to begin in mid-summer of 2004 after the completion of a final series of field tests.

As shown in Figure 10, the system uses a single blower that pulls in outside air and directs most of it through the dry side of a heat exchanger that uses 14 inch thick media to efficiently indirectly cool the air stream without adding moisture. This partially-cooled air then passes through a direct cooling module before being directed into the home. About 27 percent of the outside air stream is used in the other (wet) side of the counter-flow heat exchanger, where it is cooled, gathers moisture, and then is discharged to the outdoors. Water from both the indirect and direct cooling processes gathers in a single reservoir where it is purged with a frequency

reflective of the amount of scale in local tap water and the rate of water use by the system (which depends on the blower speed that is controlled by a thermostat).

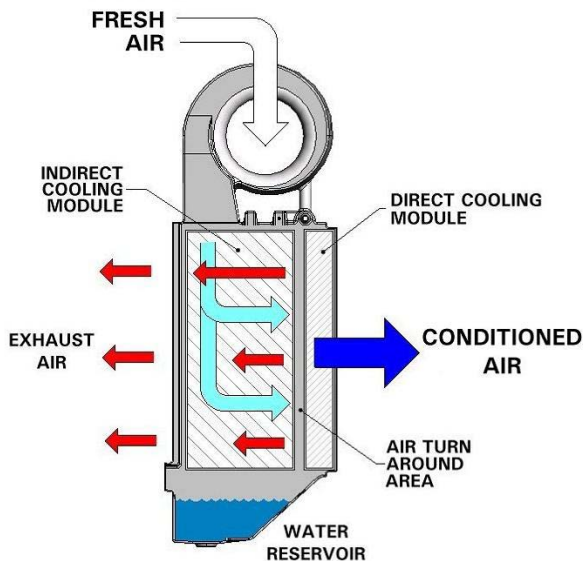

Source: Davis Energy Group

Figure 10. OASys air flow. About 73% of the fresh air pulled in by the squirrel cage blower is destined to become conditioned air. It is indirectly cooled (light blue arrows), then directly cooled (dark blue arrow) before entering the conditioned space. The remaining air (red arrows) is blown through the counter-flow heat exchanger where it is cooled and humidified before being exhausted.

This machine incorporates a number of improvements over earlier indirect/direct evaporative coolers designed for residential use. In fact, it's the third generation of indirect/direct evaporative coolers that have been developed by the Davis Energy Group. As shown in Figure 11, there is a single polyethylene cabinet that houses all parts of the system. This substantially simplifies the overall design, helps maintain tolerances, shortens assembly time, and ensures a long lifetime. An important innovation with the OAS is the electronically-commutated motor (ECM), which enables variable speed operation at high efficiency. Since ECMs are effectively parallel-wound direct current (dc) motors with electronic controls, they can make efficient use of electric energy from a dc source, such as photovoltaics (PV). In fact, an experimental OASis test unit has been modified so that it can simultaneously use the output of ac from the grid and dc from a PV system, making partial to 100% use of PV power as a function of its availability. Since the availability of PV power is typically quite high on the hottest days of the year when utilities are working to meet peak demand, this system shows promise for being part of the solution rather than part of the problem.

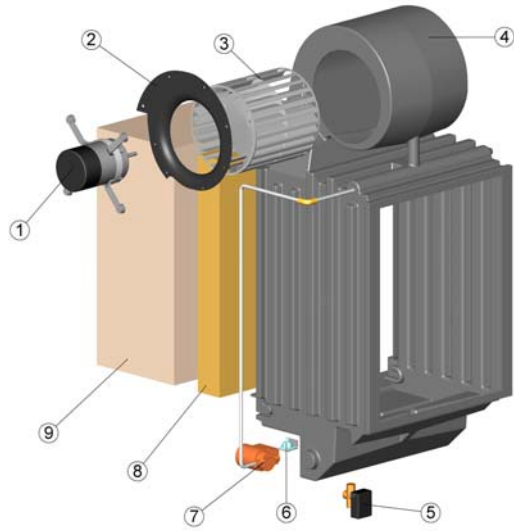

Source: Speakman CRS

Figure 11. OASys components. The part count for the system is quite low owing largely to the rotationally-molded polyethylene cabinet. 1: ¼ hp GE ECM2.3 Electronically Commutated Motor 2: Venturi mounting plate 3: Morrison 11-11 squirrel cage blower wheel 4: Polyethylene rotationally molded cabinet 5: Drain valve 6: Fill valve 7: Taco water circulator 8: Munter’s CELdek® 5090 direct cooling stage 9: Speakman indirect cooling stage

Coolers are chosen to meet peak loads, of course, but well-designed units are able to meet partial loads (which predominate over the cooling season) at substantially increased efficiency. Figure 12 shows how efficiency varies with delivered supply air flow.

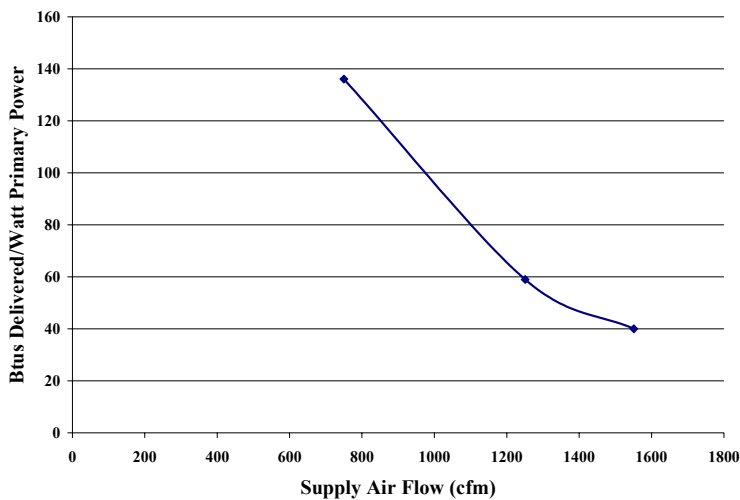

Source: Davis Energy Group; Lawrence Berkeley National Laboratory

Figure 12. OASys measured performance at three supply air flow rates. The data gathered was at entering dry bulb temperatures of 104°F, with the unit supplying dry bulb temperatures of 68°F. Power plotted is the sum of fan and pump power.

This increase in system efficiency of well over three-fold as fan speed is reduced from high to low favors intelligent thermostatic control. The thermostat that controls the OASys is programmed to operate at high speed only when the difference between its set point and indoor air temperature is greater than 5°F. As the indoor air temperature approaches the set point temperature, the thermostat lowers the fan speed incrementally, maintaining steady-state conditions at low speed when system efficiency is at a maximum.

Engineers at the Davis Energy Group took these and other test results and performed simulations of a very efficient 1600 square foot home in eight of California's climate zones. It's useful to examine the results for Fresno, which has a hot, arid climate not unlike many locations in the Southwest (1% dry bulb temp 101°F, wet bulb 70°F). The base-case home with a conventional DX air conditioning system rated at 12 SEER uses 1886 kWh/yr with a peak of 3 kW, while the OASys uses 135 kWh/yr with a peak of 0.52 kW. This amounts to an annual energy savings of 93% and a peak demand savings of 83%. Simulation results reflect a thermostat setting of 80°F for the conventional air conditioning case, but 78°F for the evaporative cooler to compensate for higher indoor humidity in the latter case.

Towards the Future

This kind of savings points the way to potentially very cost-effective adjustments in new home construction in regions in which 99 percent of the time wet bulb temperatures are 72°F or below. Building tight, well-insulated structures with careful attention to fenestration should continue, of course, as should techniques which reflect (and reradiate) sunlight striking the roof. Installing a high-quality indirect/direct evaporative cooler in the attic (or at the side of a home, with conditioning air being supplied primarily to an upstairs hall) in conjunction with well-insulated up-ducts and intelligent controls will meet the cooling needs of the home quite comfortably. Then the home could be heated via a hydronic system, optimally via a radiantly-heated slab, a system which is becoming less costly and is quite reliable. A solar hot water system could supply domestic hot water as well as a substantial portion of the low-temperature needs of the hydronic heating system in the sunny Southwestern climates, with back-up from an efficient, tankless boiler. The result would eliminate conventional duct systems with their associated economic and energy inefficiencies and achieve excellent overall cost effectiveness—as well as health, safety, and comfort.

Concerning the evaporative cooler systems themselves, there's a need to *think* of them as systems thoroughly integrated into energy-efficient structures. Techniques for sealing them carefully and simply during shoulder and winter seasons coupled with ensuring that there's no risk of freezing need to be developed. Up-ducts need to be redesigned to be thoroughly insulated and positively sealed during times when cooling isn't needed. And controls need to be developed which not only vary fan speeds and control water cleaning cycles, but also monitor efficiency performance to signal the need for maintenance. Finally, there's room for improvement in the heat exchanger technology used in indirect cooling systems, and several companies are working to develop more efficient systems which require less pressure drop to achieve more effective cooling.

The trends toward using more compressor-based air conditioning in new homes in the Southwest is disturbing given the energy-efficiency opportunity offered by modern evaporative cooling systems. The greatest barriers to acceptance of this newly-improved technology are misperceptions based on the performance of old evaporative cooling technology and the lack of awareness on the part of the buying public—and the builders who serve them. For the vast majority of the public—and the building profession—evaporative cooling means unsightly, low-tech, and often poorly-performing swamp coolers. This does not need to be the case. However, a major education and awareness-building effort is needed to convince homeowners and builders that evaporative cooling can be a high-performance alternative to conventional air conditioning systems—it's potentially much less costly over its lifetime, and can be designed to be as comfortable as the alternative.

Appendix A

Energy-Efficient Evaporative Cooling Equipment

This list includes only evaporative cooling equipment that achieves saturation effectiveness of greater than 80% under all operating conditions, variable speed motors, a sump-dump feature for effective cleaning with minimal water use, and thermostatic controls. This list is not exhaustive and should be viewed as merely representative of the higher efficiency evaporative coolers available.

Costs cited are contractor prices for the equipment itself (not installation), typically sold by local distributors. Products and prices offered by manufacturers and associated specifications change, so checking directly with the manufacturers and their representatives is strongly recommended.

AdobeAir, Inc.

550 South 15th Street
Phoenix, AZ 85034
(602) 257-0060
www.adobeair.com

Models	Pad	Effective -ness	Fan HP	Cfm @ 0.2"	Warrantee (years)	Cost
Master Cool Contractor Series						
CMC 431, 432, 441, 442	12"	90%	3/4	3180	2 motor; 5 pad	\$705
CMC 631, 632, 641, 642, 651, 652	12"	90%	1	4050	2 motor 5 pad	\$870
Master Cool HC Series						
HC 43	12"	90%	1/2	2582	2 motor; 5 pad; 10 cabinet	\$599
HC 44	12"	90%	3/4	3070	2 motor; 5 pad; 10 cabinet	\$637
HC 63	12"	90%	3/4	3646	2 motor; 5 pad; 10 cabinet	\$797
HC64	12"	90%	1	4111	2 motor; 5 pad; 10 cabinet	\$845
Master Cool Two Stage						
IM650/660	1	105%	1/5, 1	4111	2 motors; 5 pad; 10 cabinet	\$1,689 ³

³ The Master Cool Two Stage evaporative cooler is sold in two parts, an indirect module and a direct module. The cost of the indirect module is \$819. The two-stage price cited assumes that the indirect module is used with a CMC 600 series direct unit.

Champion Cooler Corporation

(Produces coolers under the Champion, Essick, and Tradewinds brands)

5800 Murray

Little Rock, AR 72209

800-643-8341

www.championcooler.com

Models	Pad	Effective-ness	Fan HP	Cfm @ 0.2"	Warrantee (years)	Cost
Essickair						
SI-500S (or D)12	12"	90%	1/2	2910	1 cabinet; 2 pad	\$880
SI-700S (or D) 12	12"	90%	3/4	3450	1 cabinet; 2 pad	\$1,080
Champion UltraCool Advantage						
ADA 5012 ASA 5012	12"	90%	1/3	2324	Reservoir lifetime 2 motor, 2 pad	\$860
ADA 5012 ASA 5012	12"	90%	1/2	2910	Reservoir lifetime 2 motor, 2 pad	\$880
ADA 5012 ASA 5012	12"	90%	3/4	3450	Reservoir lifetime 2 motor, 2 pad	\$900
ADA 7012 ASA 7012	12"	90%	1/2	3462	Reservoir lifetime 2 motor, 2 pad	\$1,060
ADA 7012 ASA 7012	12"	90%	3/4	4087	Reservoir lifetime 2 motor, 2 pad	\$1,080
ADA 7012 ASA 7012	12"	90%	1	4572	Reservoir lifetime 2 motor, 2 pad	\$1,120

N.B. Products offered by Champion may be used with purge or bleed systems as an extra feature of the customer's choice. In the case of purge (sump-dump) systems, the timer interval is fixed at 8 hours.

Phoenix Manufacturing, Inc.

3655 E. Roeser Road
 Phoenix, AZ 85040
 (602) 437-1034
 www.evapcool.com

Models	Pad	Effective -ness	Fan HP	Cfm @ 0.2"	Warrantee (years)	Cost
Aerocool Pro Series						
PD 4801/PD 4231 PH 4801/PH 4231	8"	93.5%	3/4	3050	Lifetime leakage thru base; 2 year all other components	\$726
PD 6801/PD 6231 PH 6801/PH 6231	8"	93.5%	1	4135	Lifetime leakage thru base; 2 year all other components	\$930
Aerocool Trophy Series						
TD/TH 4812	12"	90%	1/2	2645	Lifetime leakage thru base; 2 year all other components	\$600
TD/TH 4812	12"	89%	3/4	3190	Lifetime leakage thru base; 2 year all other components	\$630
TD/TH 6812	12"	90%	3/4	3820	Lifetime leakage thru base; 2 year all other components	\$730
TD/TH 6812	12"	89%	1	4300	Lifetime leakage thru base; 2 year all other components	\$750

Speakman CRS

Covington Stanwick or

Si Hyland

Speakman CRS

301 East 30th Street

Wilmington, DE 19802

(302) 764-7100

www.speakmancrs.com

Speakman CRS anticipates that its OASys will be available for sale by the 2004 cooling season. Final pricing will depend on the configuration of the system, but the manufacturer believes that the base price should be under \$3,000, before applicable rebates and incentives. The manufacturer also anticipates that the cost of installation will be substantially less than a conventional split compressor system. The total package should be cost-competitive compared to conventional systems.

Speakman CRS indicates that the OASys will be warranted to industry standards.